

# 24/7



## AAKCCD46 系列說明書 AAKCCD46 INSTRUCTION MANUAL

**KWC** KIEN WELL TOY INDUSTRIAL CO., LTD  
www.kwcgun.com

台南市仁德區義林路168巷89號  
NO.89, LN. 168, YILIN RD.,  
RENDE DIST., TAINAN CITY  
71752, TAIWAN (R.O.C.)  
TEL : +886-6-2798175  
FAX : +886-6-2798176  
sales@kwcgun.com  
www.kwcgun.com



## 操作/OPERATION

### 射擊前的準備 BEFORE SHOOTING



1. 按下卡榫  
Press the button.

2. 取出彈匣  
Release the magazine.

3. 使用六角扳手反時針方向取出彈匣底內件。  
Use hexagonal wrench to remove the magazine cap by counter clockwise.

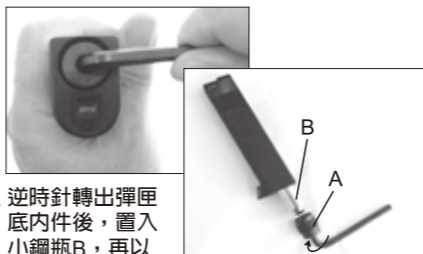

4. 逆時針轉出彈匣底內件後，置入小鋼瓶B，再以順時針方向鎖緊彈匣底內件A。當刺破鋼瓶出氣時，請快速鎖緊。

Turn the magazine cap out counter-clockwise and place CO2 cartridge B inside the magazine. Rapidly turn the screw A clockwise when piercing the cartridge in the magazine.

5. 拉下滑粒。  
Pull the magazine follower down.



6. 填裝BB粒。  
Loading BBs  
為了使擊發順暢，填裝方法是讓BB彈在彈匣中一粒接著一粒。  
For smooth shooting, Load BBs one by one.

7. 最多可裝15粒。  
Maximum BB capacity is 15 rounds.

### 射擊 SHOOTING

1. 將裝好B.B彈的彈匣插入槍身上推入，直到彈匣卡榫發出“卡嗒”為止。  
Insert fully loaded magazine in the airsoft until you hear the sound of “CLICK”.



2. 瞄準目標物扣引扳機，即可擊發。  
Aim the target and pull the trigger.



▲注意：在長期不使用的狀態下，請將彈匣內的氣體洩放掉。

▲CAUTION：Release all of the gas in the magazine when it is unused in long-term period.

### 安全裝置 SAFETY

可射擊  
SAFETY OFF



保險  
SAFETY ON



## 故障/BREAK DOWN

### 故障的原因與排除 BREAK DOWN FAQ

1. 不良的B.B彈是造成卡彈的原因，請使用品質優良的KWC B.B彈。  
Bad quality BB is the main reason to cause BB jam. Please use the best quality KWC BB to avoid jamming problem.

2. 當卡彈時，請盡可能先取出彈匣，再以不傷槍管的軟質細棒(不可大於6mm直徑)從槍口置入清除。  
When BB jammed, first please release the magazine from pistol then use a soft stick (diameter no bigger than 6mm) to clear up the barrel.

3. 空擊發易造成零件損耗，請避免此動作。  
Please avoid dry firing, for it could cause parts deformed or damage.

4. 當扣引扳機時，此時B.B彈即同時在上膛階段，不可扣引一半時又回復，因為如此的動作，將有可能上膛兩發B.B彈。  
Pulling trigger will load BB in the barrel. Therefore, please do not pull the trigger half way and release the trigger. This action could load 2 BBs in the pistol and cause jamming.

5. 使用一段時間後，請再次用中性矽油脂潤滑撞針及扳機軸心。  
Please spray the lubricant into firing pin and trigger pin.



### ⚠ WARNING

請務必嚴格遵守 使用說明指導書  
For your safety, please read this manual carefully before use.

此低動能遊戲用槍是針對喜愛射擊運動的消費者所開發。避免因使用方法不正確或改造所發生的故障或事故，請務必詳讀說明書，正確的操作享受愉快的射擊運動。

- 除了發射時外，不要將手指頭掛在板機上。
- 選擇安全與適當標靶
- 在非使用期間，請保持保險關閉且退彈的狀態，就算在非使用狀態，也要如同其已裝彈。
- 如任何的機械產品，槍的保險也可能失效。即使在保險關閉的狀態下也請小心的操作此槍，請勿將槍口對人。
- 千萬不要對堅硬或平坦表面、水面擊射，以避免跳彈。
- 請妥善保管產品在未未成年孩童無法伸手取得的場所。
- 每次使用前後都應該檢查擋彈物，假如擋彈物表面有磨損失效或是反彈時請停止使用。
- 請使用高品質BB彈，請勿使用①口徑大於6mm ②表面不平滑的③重複使用過的BB彈④非本說明書指名的發射物。
- 最高的使用及儲藏CO2小鋼瓶環境為50°C (122°F)以內，高溫可能會造成CO2小鋼瓶過熱甚至爆炸。
- 檢查任何掉落之槍枝，以確保未影響其功能。

This airsoft is intended for recreational or training purposes. To prevent improper handling, modification or alteration causing malfunction or accident, please read the owner's manual carefully. Enjoy the pleasant shooting experience by proper operation.

- Do not put your finger on the trigger except shooting.
- Please choose safe and proper target.
- Please always keep the airsoft on safe and unloaded when not using.
- Like all mechanical devices, an airsoft safety can fail. Always handle the airsoft safely even when the safety is "on safe". Never point the airsoft at any people.
- Avoid ricochet. Never shoot at a hard or flat surface or at water.
- Keep the airsoft out of reach for small children.
- Your backstop should be inspected for wear before and after each use. Discontinue use of the backstop if surface shows signs of failure or ricochet.
- Only use high quality BB. Never use ①BB diameter larger than 6mm ②BB with unsmoothed surface ③reused BB that has been fired ④incorrect projectiles not design for this airsoft.
- Do not expose CO2 cartridges to heat or store them at temperatures above 50°C (122°F). CO2 cartridges may over heat or explode at temperatures above 50°C (122°F).
- Check any gun that has been dropped to ensure that its function has not been affected.

# WARNING 警告

## AAKCCD46 系列 零件表 AAKCCD46 SERIES PARTS LIST

## AAKCCD46 系列 零件分解圖 AAKCCD46 SERIES EXPLODED VIEW

★使用玩具槍前，請務必戴上保護眼鏡或面罩。  
★Always wear eye protection when using airsoft.

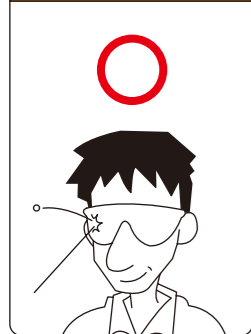

★不可攜帶玩具槍在公共場所行走，請務必裝在袋子或盒子內。  
★Always transport an airsoft in a locked carrying case. Make sure it is unloaded and on safe.

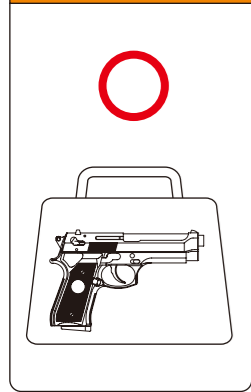

★使用玩具槍前，請務必詳讀說明書內容。  
★Read the owner's manual before using the airsoft.

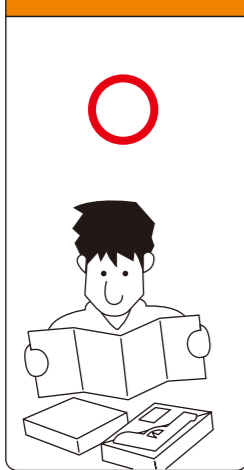

★請不要由槍口向內探視。  
★To Avoid accidental discharge, do not look directly into the barrel.



★請不要在公開場合使用玩具槍，也請不要拿玩具槍對準人或動物。  
★Never brandish or aiming this airsoft at any people or domestic animals. Brandish this airsoft in public is dangerous and may be a crime.

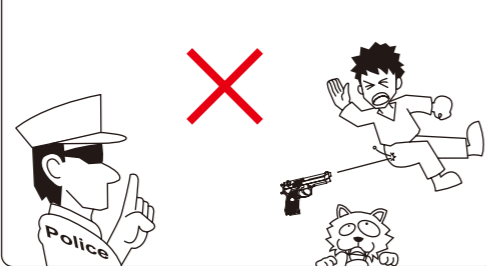

★請確認後再發射BB彈方向，附近無人或動物存在。  
★Always be aware of your surrounding before and during shooting and select a safe area for target practice.

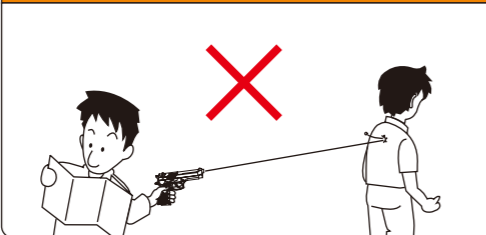

★不可任意改造或加工玩具槍，私自改造加工會造成產品損壞、保固失效，導致使用上不安全，甚至觸法送辦。  
★Disassemble, modify, or alter your airsoft may cause malfunction, void your warranty and may make it unsafe to use.

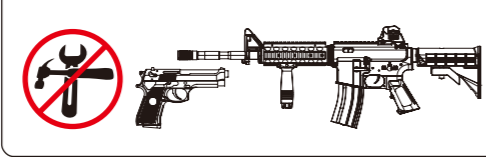

NO.	零件名稱	UNIT
P31	心棒蓋迫緊	VALVE PACKING
P403	彈匣底內件	MAGAZINE BOTTOM CAP
P417	彈匣滑粒	MAGAZINE FOLLOWER
P460	槍身上蓋	SLIDE(PLASTIC)
P461	擊鐵箱(左)	CHASSIS(L)
P462	擊鐵箱(右)	CHASSIS(R)
P465	保險左(新規)	SAFETY(L)
P466	上蓋止動片	SLIDE STOPPER
P468	彈匣底座定位件	MAGAZINE BASE JOINT
P469	導管配件	OUTER BARREL COVER
P601	槍身本體	FRAME
P603	槍柄(射包)	GRIP
P607	彈匣卡榫	MAGAZINE CATCH
P727	槍管套(KA.KG)	OUTER BARREL CAP
Z442	撞針	FIRING PIN
Z462	上蓋(鋅合金)	SLIDE(METAL)
Z465	扳機	TRIGGER
Z468	扳機連動件	TRIGGER CONNECTOR
Z469	槍管連動件	BARREL TOW
B19	心棒蓋	VALVE CAP
B33	氣瓶頂針(新)	PUNCTURE VAVLE
B215	氣瓶頂針迫緊	PUNCTURE VAVLE PACKING
B461	槍管	BARREL
B465	心棒	VALVE
B468	撞針軸(新)	FIRING PIN AXLE
F03	軸(擊鐵)	PIN (HAMMER)
F401	心棒壓簧墊圈	VALVE SPRING GASKET
F464	扳機連桿	TRIGGER BAR

NO.	零件名稱	UNIT
F465	扳機連桿壓簧軸	TRIGGER BAR SPRING PIN
F468	保險釋放件(新規)	SAFETY RELEASE
F601	軸(擊鐵箱用)	PIN(CHASSIS)
F705	平頭軸(活塞卡榫用)	PIN (PISTON CATCH)
SM04	扳機連動件扭簧	TRIGGER CONNECTOR SPRING #04
SM05	扳機連動件壓簧	TRIGGER CONNECTOR SPRING #05
SM63	撞針扭簧	FIRING PIN SPRING
S401	彈匣壓簧	MAGAZINE SPRING
S404	心棒壓簧	VALVE SPRING
S406	扳機扭簧	TRIGGER SPRING
S613	彈匣卡榫線簧	MAGAZINE CATCH SPRING
S461	扳機連桿壓簧	TRIGGER BAR SPRING
S466	保險釋放件扭簧	SAFETY RELEASE SPRING
S804	撞針緩衝扭簧(新規)	FIRING PIN BUFFER SPRING
E01	E型扣環	E-RING
E03	⊕2.3X8束黑 螺絲	SCREW 2.3X6
E04	⊕2.3X6尖黑熱 螺絲	SCREW 2.3X6
R01	子彈迫緊	RUBBER CHAMBER
R02	O形環 1.45X6.9id	O-RING 1.45X6.9id
R03	O形環 1X5	O-RING 1X5
R04	O型環 1X4	O-RING 1X4
R05	O型環 φ0.8xφ11.3id	O-RING φ0.8xφ11.3id
R07	O型環 1X7	O-RING 1X7
R08	O形環 1X3	O-RING 1X3
U02	六角扳手	WRENCH
U1	內槍管組件	INNER BARREL UNIT
U2	氣瓶頂針組件	PUNCTURE VAVLE UNIT

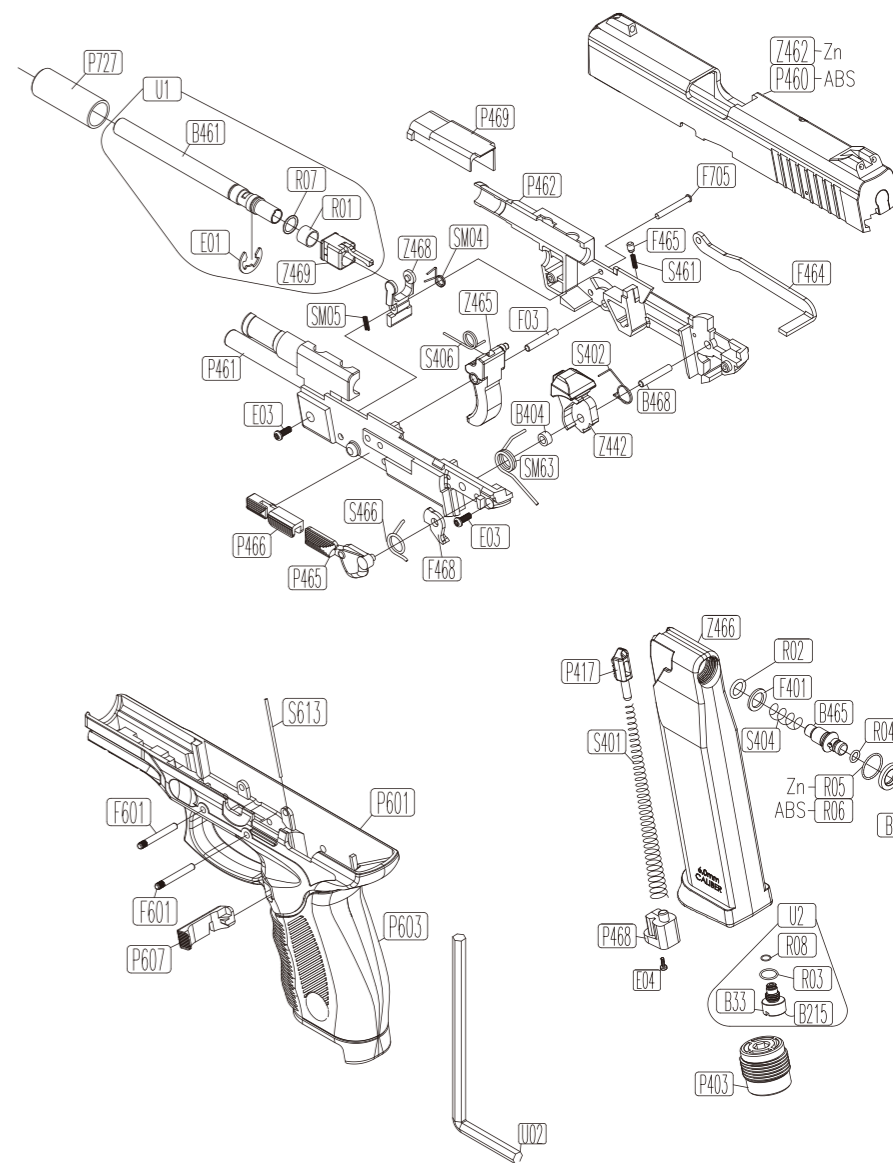

※零件有時為了改良而不經預告變更。  
Spare parts may be modified for quality improvement  
And such modification may be without advance notice.

Do not display this pistol in public—it may confuse people and may be a crime.  
請不要忘了，雖然自己知道這只是玩具，但不知道的人，會以為這是真槍。